



- Aluminium electronic enclosure for telecommunication and MCR technology
- Variable length version using profile technology
- Screw-down fins integrated into sides
- Different lid versions depending on enclosure type
- Integrated guide grooves for PCB's

Technical data

Material:

DIN EN 573 EN AW-AlMgSi

Ingress protection:

IP 65 or IP 40 to EN 60529
depending on lid versions

Painting:

Powder coating

Colour:

RAL 9005, jet black

Temperature range:





-30°C to +80°C

Included in delivery

Enclosure with two sheet aluminium or cast lids, screwed

Profitronic I

Product range

Type	Order No.	External enclosure dimensions* W x L x H (mm)	Version	Weight (g)	Ingress protection	max. PCB dimensions (mm)
07.01 	07.01 01 17	105 x 175 x 45	2 sheet aluminium lids without seal, standard length = 170 mm	510	IP 40	100 x 170
07.02 	07.02 01 17	105 x 175 x 69	2 sheet aluminium lids without seal, standard length = 170 mm	580	IP 40	100 x 170
07.03 	07.03 12 22 07.03 13 22	196/166 x 239 x 106 196/166 x 232 x 106	2 cast aluminium flat lids with seal, cast aluminium flat lids and mounting rear panel standard length = 220 mm	2420 2240	IP 65 IP 40	100/160 x 220 100/160 x 220
07.10 	07.10 06 18	105 x 198 x 73,5	2 cast aluminium flat lids with seal standard length = 180 mm	770	IP 65	100 x 180
07.11 	07.11 06 18	105 x 200 x 49	2 cast aluminium flat lids with seal standard length = 180 mm	790	IP 65	100 x 180

* Dimensions without fixing brackets

EMC version: product group 70.xx xx xx

Dimensions

Version IP 40

Type 07.01

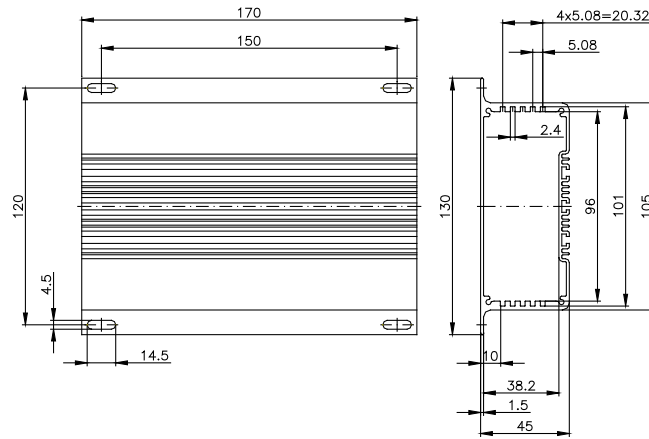

Type 07.02

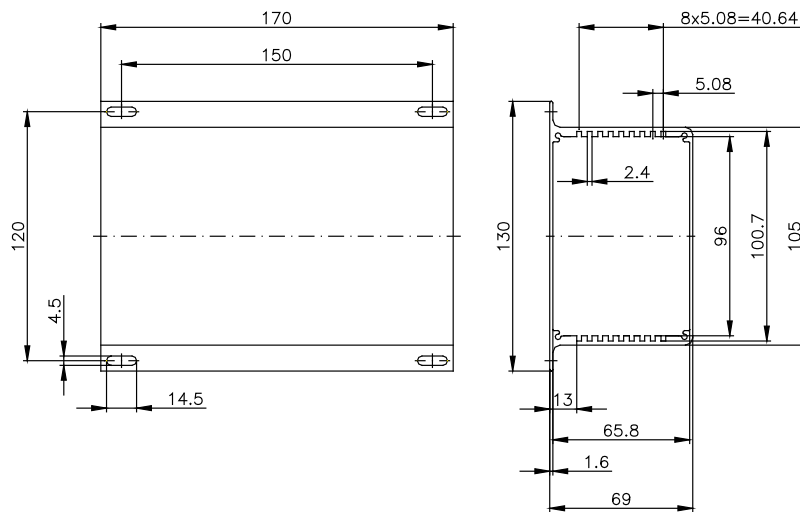

Type 07.03 (07.03 13 22)

